

# 13'-0" GEO ROOF

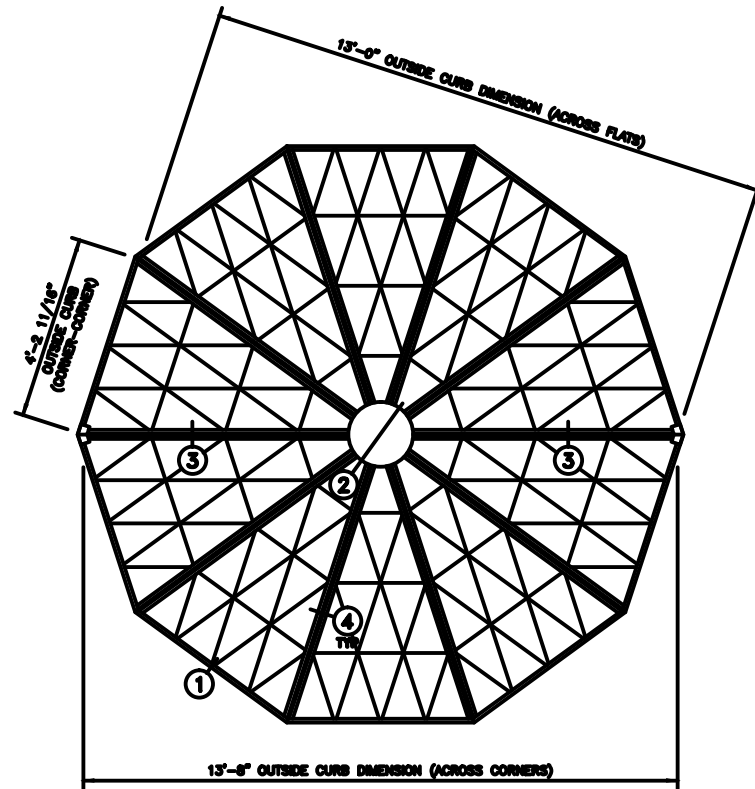

**GEO ROOF PLAN**  
NOTE: SHIPPED IN 2 UNITS

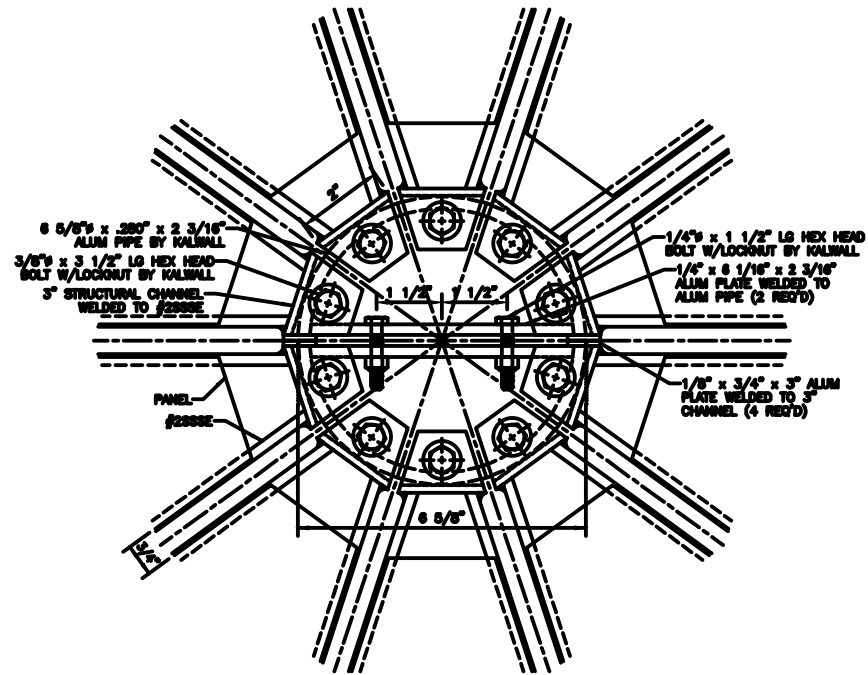

**AA COMPRESSION RING PLAN VIEW**

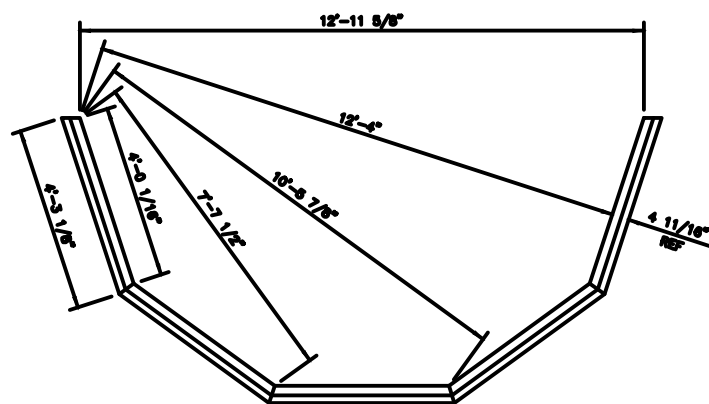
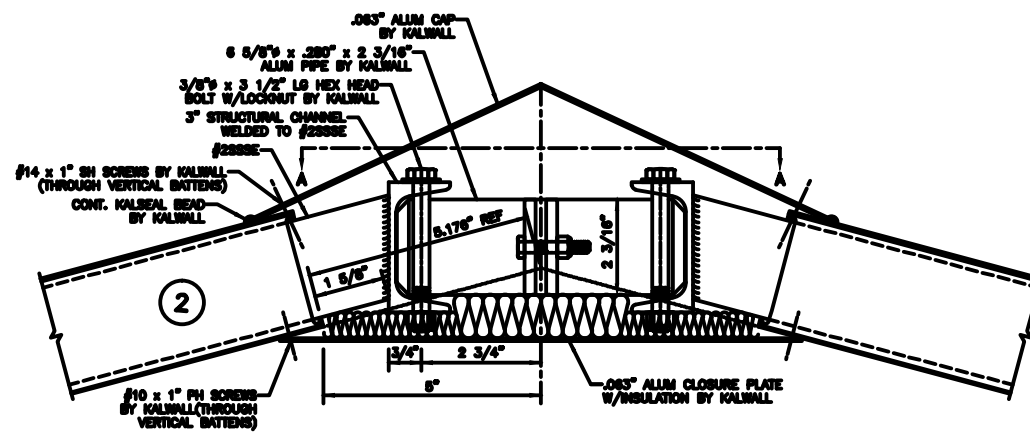
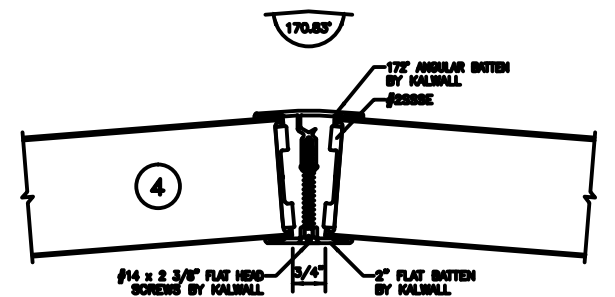
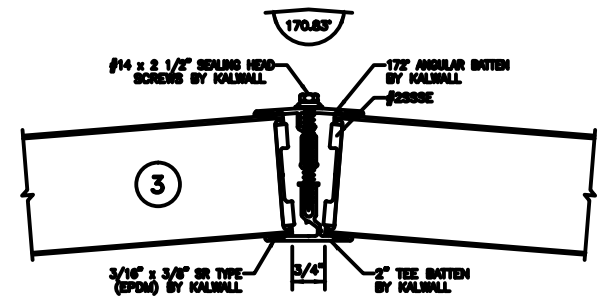

**INSTALLATION DIMENSIONS FOR CURB CAP LAYOUT OF HALF THE GEO ROOF**

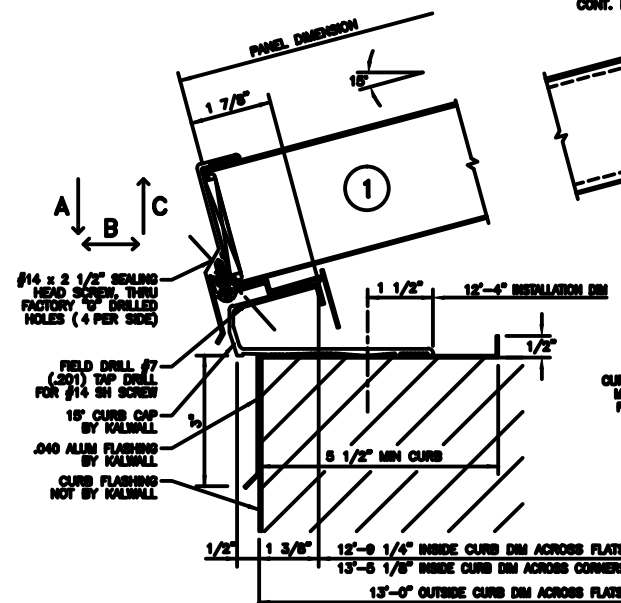

**\*\*FORCES NOTE\*\***  
CURB CONSTRUCTION NOT BY KALWALL MUST BE DESIGNED TO RESIST THE FOLLOWING FORCES PRODUCED BY:  
A: PSF LIVE LOAD  
A: PSF WIND LOAD  
A: PSF SNOW LOAD  
A: \_\_\_\_\_ LBS/SIDE  
B: \_\_\_\_\_ LBS/SIDE  
C: \_\_\_\_\_ LBS/SIDE

CURB TYPE	FASTENER #	SPACING
WOOD	#14 KAL S.S. - 4" LG.	6" O.C.
STEEL	#14 KAL S.S. - 1" LG.	24" O.C.
CONCRETE	1/4" x 3 1/4" POWER BRD OR #404	16" O.C.

\*NOT SUPPLIED BY KALWALL UNLESS INSTALLED BY KALWALL

**NOTE:**  
INSTALLER TO SET ENTIRE PERIMETER EDGE IN A CONTINUOUS BED OF CAULKING, AND ISOLATE ALUMINUM FROM DISSIMILAR MATERIALS TO PREVENT ELECTROLYSIS.

**KALWALL**<sup>®</sup>  
high performance translucent building systems